

HindPhotostat



Hind Photostat & Book Store

Best Quality Classroom Topper Hand Written Notes to Crack GATE, IES, PSU's & Other Government Competitive/ Entrance Exams

MADE EASY ELECTRICAL ENGINEERING Power System-1 By. Balaji Sir

- Theory
- Explanation
- Derivation
- Example
- Shortcuts
- Previous Years Question With Solution

Visit us:-www.hindphotostat.com

Courier Facility All Over India
(DTDC & INDIA POST)
Mob-9311989030



HindPhotostat



MADE EASY , IES MASTER , ACE ACADEMY , KREATRYX

**ESE , GATE, PSU BEST QUALITY TOPPER HAND WRITTEN NOTES
MINIMUM PRICE AVAILABLE @ OUR WEBSITE**

- | | |
|--------------------------------|---------------------------|
| 1. ELECTRONICS ENGINEERING | 2. ELECTRICAL ENGINEERING |
| 3. MECHANICAL ENGINEERING | 4. CIVIL ENGINEERING |
| 5. INSTRUMENTATION ENGINEERING | 6. COMPUTER SCIENCE |

IES , GATE , PSU TEST SERIES AVAILABLE @ OUR WEBSITE

❖ IES –PRELIMS & MAINS

❖ GATE

➤ **NOTE;- ALL ENGINEERING BRANCHS**

➤ **ALL PSUs PREVIOUS YEAR QUESTION PAPER @ OUR WEBSITE**

PUBLICATIONS BOOKS -

**MADE EASY , IES MASTER , ACE ACADEMY , KREATRYX , GATE ACADEMY , ARIHANT , GK
RAKESH YADAV , KD CAMPUS , FOUNDATION , MC –GRAW HILL (TMH) , PEARSON...OTHERS**

HEAVY DISCOUNTS BOOKS AVAILABLE @ OUR WEBSITE

F230, Lado Sarai New Delhi-110030 Phone: 9311 989 030	Shop No: 46 100 Futa M.G. Rd Near Made Easy Ghitorni, New Delhi-30 Phone:9711475393	F518 Near Kali Maa Mandir Lado Sarai New Delhi-110030 Phone: 9560 163 471	Shop No.7/8 Saidulajab Market Neb Sarai More, Saket, New Delhi-30
--	--	--	--

Website: www.hindPhotostat.com

Contact Us: 9311 989 030

Courier Facility All Over India

(DTDC & INDIA POST)

Standard voltages used in India :-

HVAC RMS line to line voltage / (line voltage (kV)) :

Transmission Network voltage (kV) -

- 1200 kV (maximum in India) Maharashtra
- 765, 400
- 220, 132
- 66

Distribution Network voltages (kV) -

- 33 kV, 11 kV

Industrials uses - 6.6 kV, 3.3 kV, 1.1 kV, 400V

Houses uses - 230V (phase voltage)

Frequency $f = 50 \text{ Hz}$

HVDC $\pm 500 \text{ kV}$, $\pm 800 \text{ kV}$, $f = 0 \text{ Hz}$

Q.N:- The rated voltage of a 3-phase power system is -
- RMS line to line voltage

All India Installed capacity sector : 382.730 GW

Coal : 209294.5 MW

Gas : 24924 MW

Nuclear : 6780 MW

Hydro : 46209.22 MW

Diesel : 509.71 MW

Renewable Energy : 95012.59 MW
source

WR : 74320 MW by coal largest power utilisation
NER : 770 MW by coal smallest

Thermal : Coal + Lignite + Gas + Diesel

30th June 2021 → maximum power consumed by 193 GW at 12:46 pm

variable load curve : All India Demand (GW) v/s time

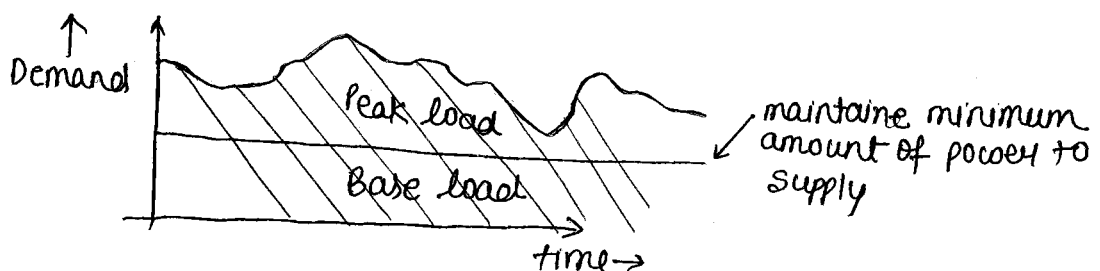

Base load :- Thermal plant

Next to peak load : Geas, wind, solar

Peak load :- Hydro plant

1 kWh = 1 unit

2019-20 1208 kWh per capita consumption

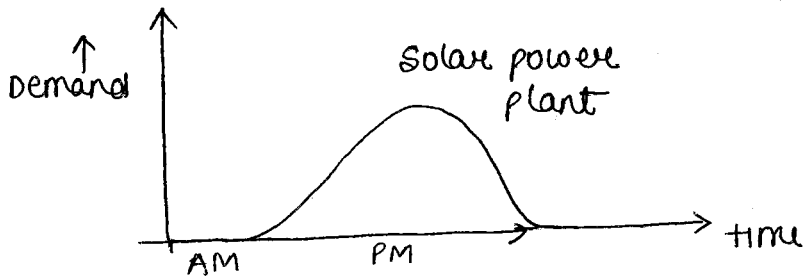

Objectives of power system :-

(i) Cost of electric energy must be low.

- Economic factors
- Economic load dispatch

(ii) Reliable power supply i.e; no interruption of power supply

- power generation methods
- Transmission
- Distribution
- Load flow studies

(iii) Maintain constant voltage i.e; supply rated voltage to consumer

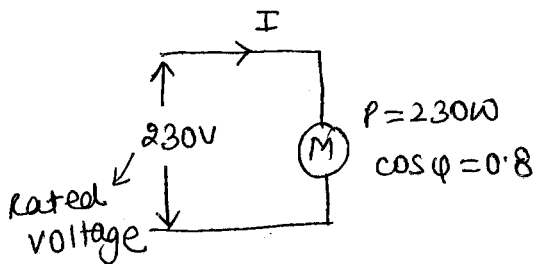

$$P = VI \cos \phi$$

$$I = \frac{P}{V \cos \phi} = \frac{230}{230 \times 0.8} = 1.25 \text{ A}$$

suppose supply voltage get reduce to $V = 200$ volts then current drawn

by motor will be $I = \frac{230}{200 \times 0.8} = 1.4375 \text{ A}$.

$$\% \text{ increase in current} = \frac{1.4375 - 1.25}{1.25} \times 100 = 15\%$$

current drawn by motor is high value, this will causes overheating

To get constant voltage — voltage / reactive power control

(iv) Maintain Rated frequency

$$f = 50 \text{ Hz} \pm 1\% \quad (49.5 \text{ to } 50.5) \text{ Hz (ideal case)}$$

$$= 50 \text{ Hz} \pm 3\% \quad (48.5 \text{ to } 51.5) \text{ Hz (practical case)}$$

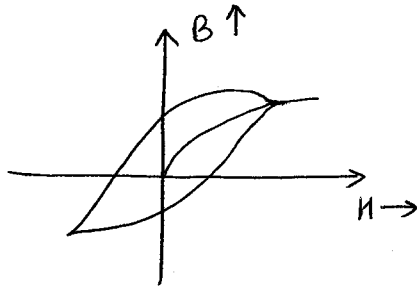

power T/F: $V = 4.44 f \Phi_m N$

$$\downarrow f \propto \Phi \uparrow \rightarrow \text{causes core saturation}$$

for this \rightarrow load frequency control

(v) Faster fault identification and clearance of fault in minimum time

- fault analysis
- protection

(vi) stable generation has to be maintained

- stability

(viii) flexible power transfer

- power cable

Parthol	- 132 KV
Zebra	- 220 KV
Moose	- 400 KV

- ° Transmission line Parameters & Performance ° -

By using transmission line, electric power is transfer from the remote generating station to the load centre (electric power utilised).

Material of Transmission line ° -

ACSR - Aluminium conductor steel Reinforced

steel is used at the centre because it has higher mechanical strength to withstand and carry large weight of ACSR conductor.

4 layer ACSR (37-30|7)

strands ← Al steel

5 layer ACSR (61-54|7)

strands ← Al steel

$$\text{No. of strands : } N = (3x^2 - 3x + 1)$$

$$\text{Total Dia } D = (2x - 1)d$$

x = layer number

d = dia of each strands

Technical name of ACSR ° - Animal like, Zebra, Panther, Moose, Dog etc is used for Aluminium for European standard and bird name like Swan, Sparrow, Raven, Pigeon etc is used as for US standard.

Power carrying capacities at 65°C ° -

At 132 KV with 'Panther' ACSR = 75 MVA

At 220 KV with 'Zebra' ACSR = 200 MVA

At 400 KV with 'Moose' ACSR = 500 MVA

$$3\phi \text{ T/L } \Rightarrow \sqrt{3} V \cdot I \cdot \cos \phi = P_{3\phi}$$

$$\sqrt{3} \times 400 \times 10^3 \times I \times 0.95 = 500 \times 10^6$$

$$I = 759.67 \text{ A carrying current by Moose}$$

Tower configuration ° -

3 bundle conductor not practically used due to mechanical strength.

conductance (G_1) :- The leakage current flowing through the supporting insulator is represented by the conductance parameter. Its value is very small and hence neglected in case of short & medium line and consider in the long transmission.

Electrical equivalent of leakage current \Rightarrow conductance (G_1)

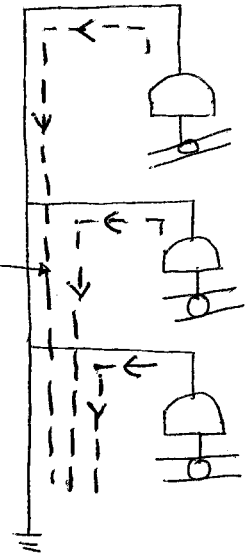

leakage current due to small value of resistance in insulator (Negl.)

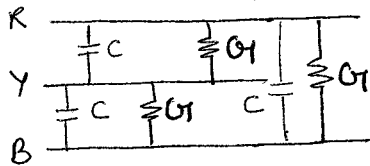

series element $\Rightarrow R \ \& \ L$
shunt element $\Rightarrow C \ \& \ G_1$

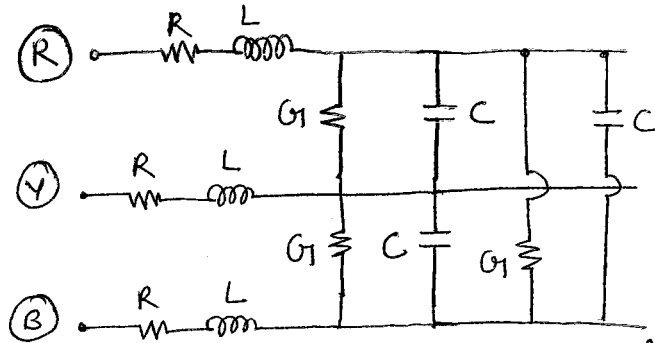

Electrical eq^t of x-mission line :-

Resistance :-

HVAC :-

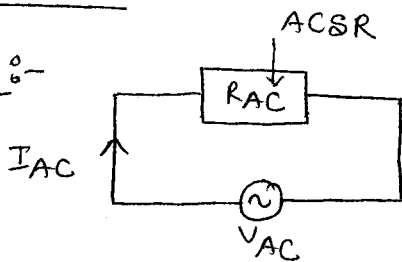

HVDC :-

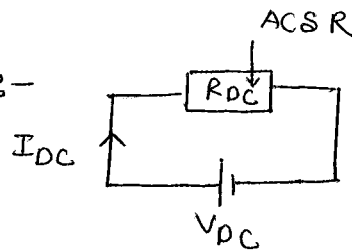

$R_{AC} > R_{DC}$

due to (i) skin effect
(ii) proximity effect

$R_{AC} = 1.5 R_{DC}$

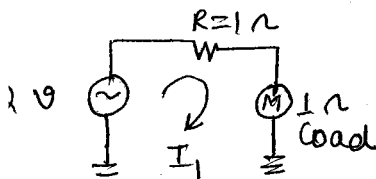

$I_1 = \frac{2}{1+1} = \frac{2}{2} = 1A$

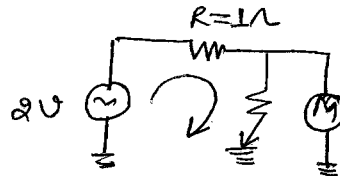

$I_2 = \frac{2}{1} = 2A$

$I_2 = 2I_1$ during short ckt condition

Short ckt rating : KA/S [maximum current able to withstand during fault]

RTS : KN

(i) skin effect :-

① Accumulation of the current on the surface of conductor is called skin effect

② Outwards current

current flowing in the conductor producing flux to the adjacent of conductor

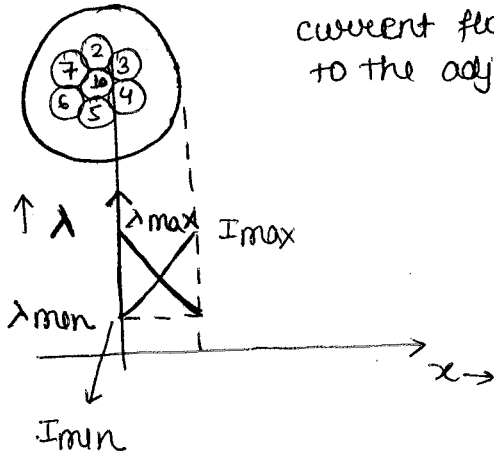

λ_{max} i.e; L_{max} then $X_L \uparrow$

$$\downarrow I = \frac{V}{X_L \uparrow}$$

λ_{min} i.e; L_{min} then $X_L \downarrow$

$$\uparrow I = \frac{V}{X_L \downarrow}$$

HVDC :

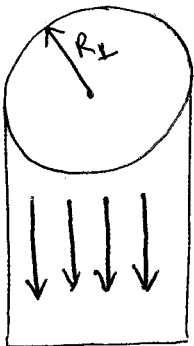

uniform current is flowing because there is no rate of change of flux.

$$R_{DC} = \frac{\rho l}{\pi R_1^2}$$

HVAC :

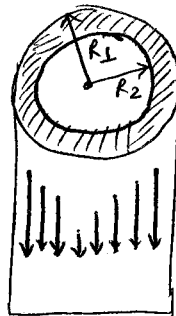

$$R_{AC} = \frac{\rho l}{\pi (R_1^2 - R_2^2)}$$

② Due to skin effect, effective area of current flowing path is reduced which causes $R_{AC} > R_{DC}$ in HVAC system.

③ skin effect depends on f , σ , μ_r and size of the conductor.

④ skin effect is more in communication line because frequency is in MHz range and this effect is neglected in power lines because the frequency is less (50Hz) only.

f = supply frequency, μ_r = Relative permeability, σ = conductivity

Skin depth (δ) :-

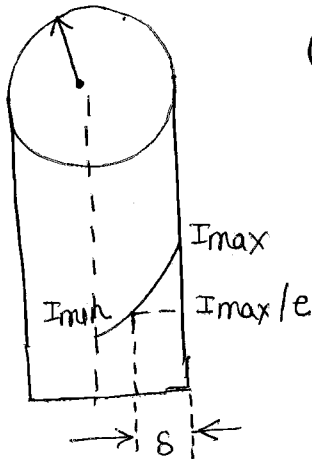

(a) The depth of the conductor at which the current is drop to $(1/e)$ time of the maximum current & that depth is called as skin depth.

$$\delta = \frac{1}{\sqrt{\pi f \mu_0 \mu_r \sigma}} \propto \frac{1}{\text{skin effect}}$$

- (b) when skin depth is less then more accumulation of current on the surface of conductor, then skin effect will be more
- (c) In HVDC, no skin effect because $f = 0$

Proximity effect :-

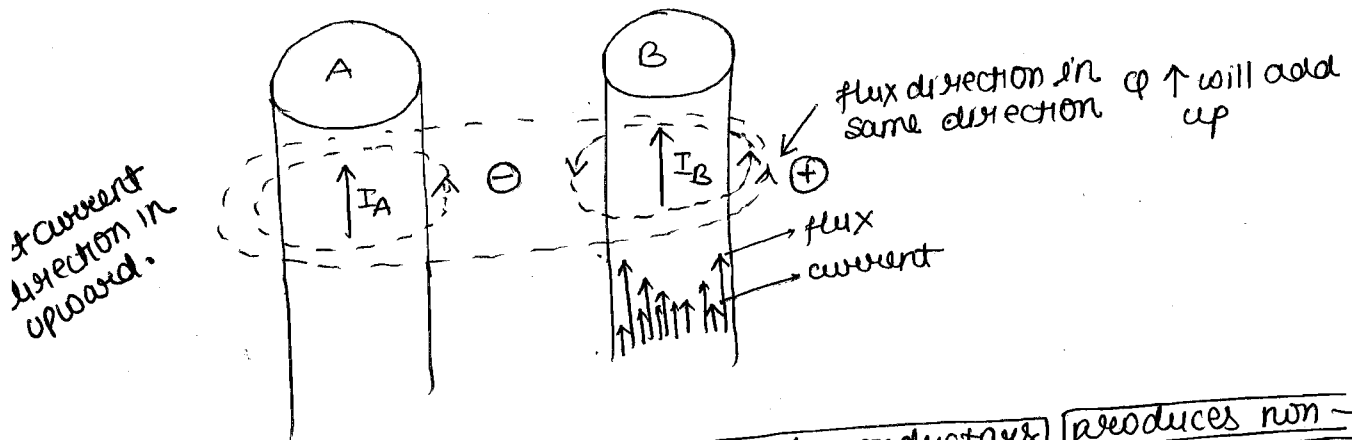

- (a) The current flowing in the adjacent conductors produces non-uniform flux linkage which will cause non-uniform current flow so, that the effective area of current flowing path is reduce which causes $R_{AC} > R_{DC}$ (we are not able to use whole area).
- (b) Proximity effect depends on f, μ_r, σ & distance between the conductor.
- (c) This effect is more in power cable and less in overhead transmission line because .